

**ARMCHAIR**

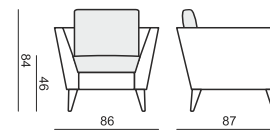

**2 SEATER**

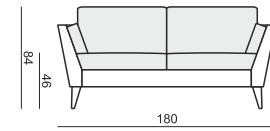

**2,5 SEATER**

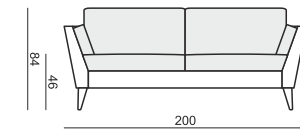

**3 SEATER**

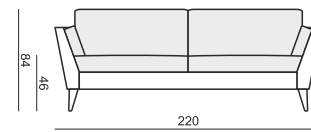

**BACKRESTS with CUSHIONS**

for ARMCHAIR



for 2 SEATER

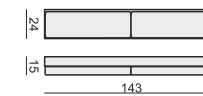

for 2,5 SEATER

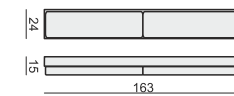

for 3 SEATER

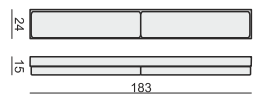

**EXAMPLE OF LEATHER COVER  
3 SEATER**

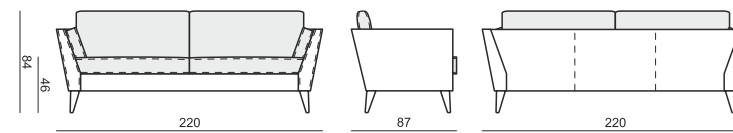

**SET 1 RIGHT (or LEFT)**  
2 SEATER LEFT (or RIGHT) + CHAISELONGUE RIGHT (or LEFT)

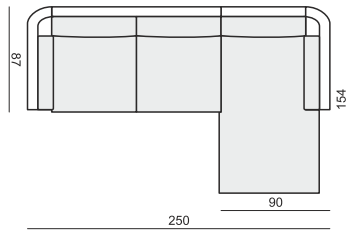

**SET 2 RIGHT (or LEFT)**  
3 SEATER LEFT (or RIGHT) + CHAISELONGUE RIGHT (or LEFT)

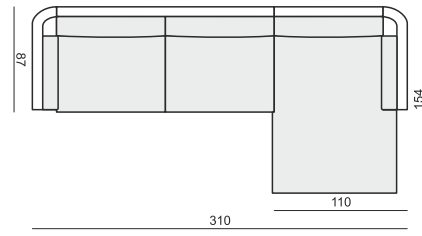

**SET 3 RIGHT (or LEFT)**  
2 SEATER LEFT (or RIGHT) + DIVAN RIGHT (or LEFT)

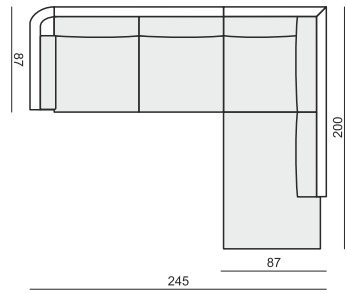

**SET 4 RIGHT (or LEFT)**  
3 SEATER LEFT (or RIGHT) + DIVAN RIGHT (or LEFT)

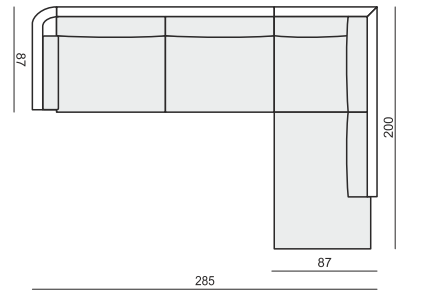

**SET 5 LEFT (or RIGHT)**  
2 SEATER LEFT (or RIGHT) + CORNER 90° + 3 SEATER RIGHT (or LEFT)

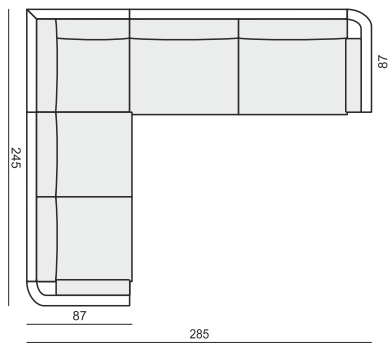

**SET 6**  
2 SEATER LEFT + CORNER 90° + 2 SEATER RIGHT

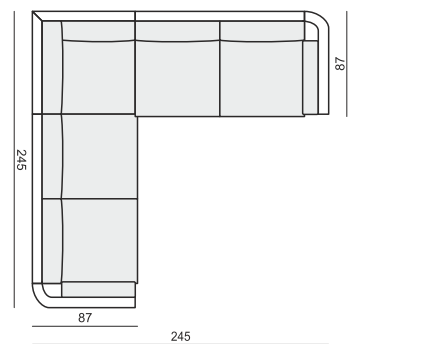

**SET 7**  
3 SEATER LEFT + CORNER 90° + 3 SEATER RIGHT

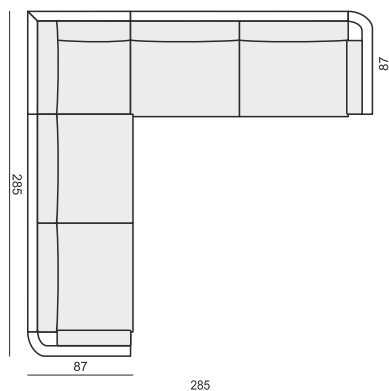

SITS reserves the right to change construction of products and components used due to improving durability of product and customer satisfaction without any further notice. Explicit ±2 cm tolerance of all elements sizes.



**UPHOLSTERY**      **FABRIC or LEATHER: FC - fix cover**

**FEET**

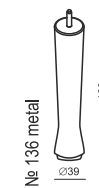
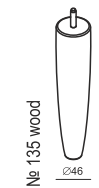
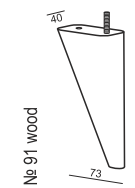

**STANDARD COMFORT**